











## 300x320 SHI-LR (II. generace/generation)

	$\square 0^\circ$	$\nabla 45^\circ$	$\nabla 60^\circ$	$\sphericalangle 45^\circ$	$\sphericalangle 60^\circ$	$\begin{matrix} a & b \\ \hline a & b \end{matrix}$
	300	300	200	270	x	x
	180*	110*	80*	110*	x	x
	320x300	290x300	190x190	270x200	x	320x160

					
3x400V	2,4	20-100	3660x27x0,9		650
L	Bmin	Hmin	Hmax	V	
2050	1170	1420	2040	800	

\* doporučená hodnota. Při překročení doporučeného maximálního průměru není možné garantovat výkon pilového pásu!  
/recommended value. The blade performance cannot be guaranteed when the recommended diameter is exceeded!

<sub>a x b</sub> - řezání svazků bez horního přitlaku / cutting of the bundle without top clamping/

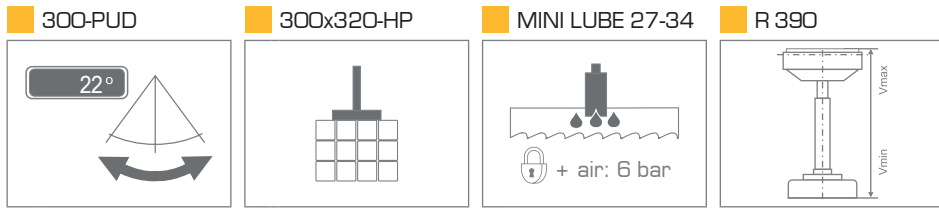
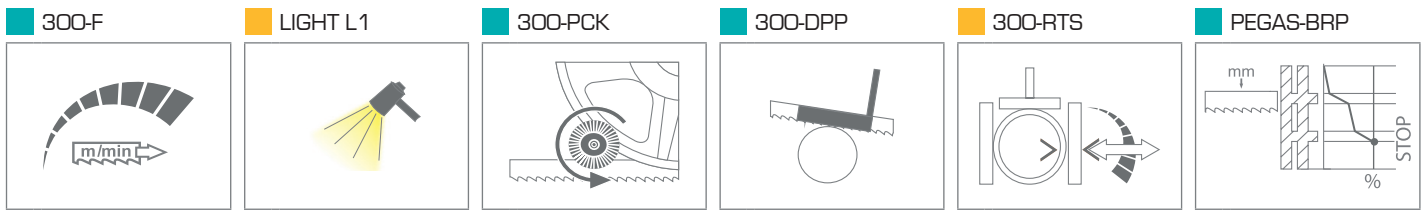

	S (mm)	Vmin (mm)	Vmax (mm)
<b>R</b>	390	760	980

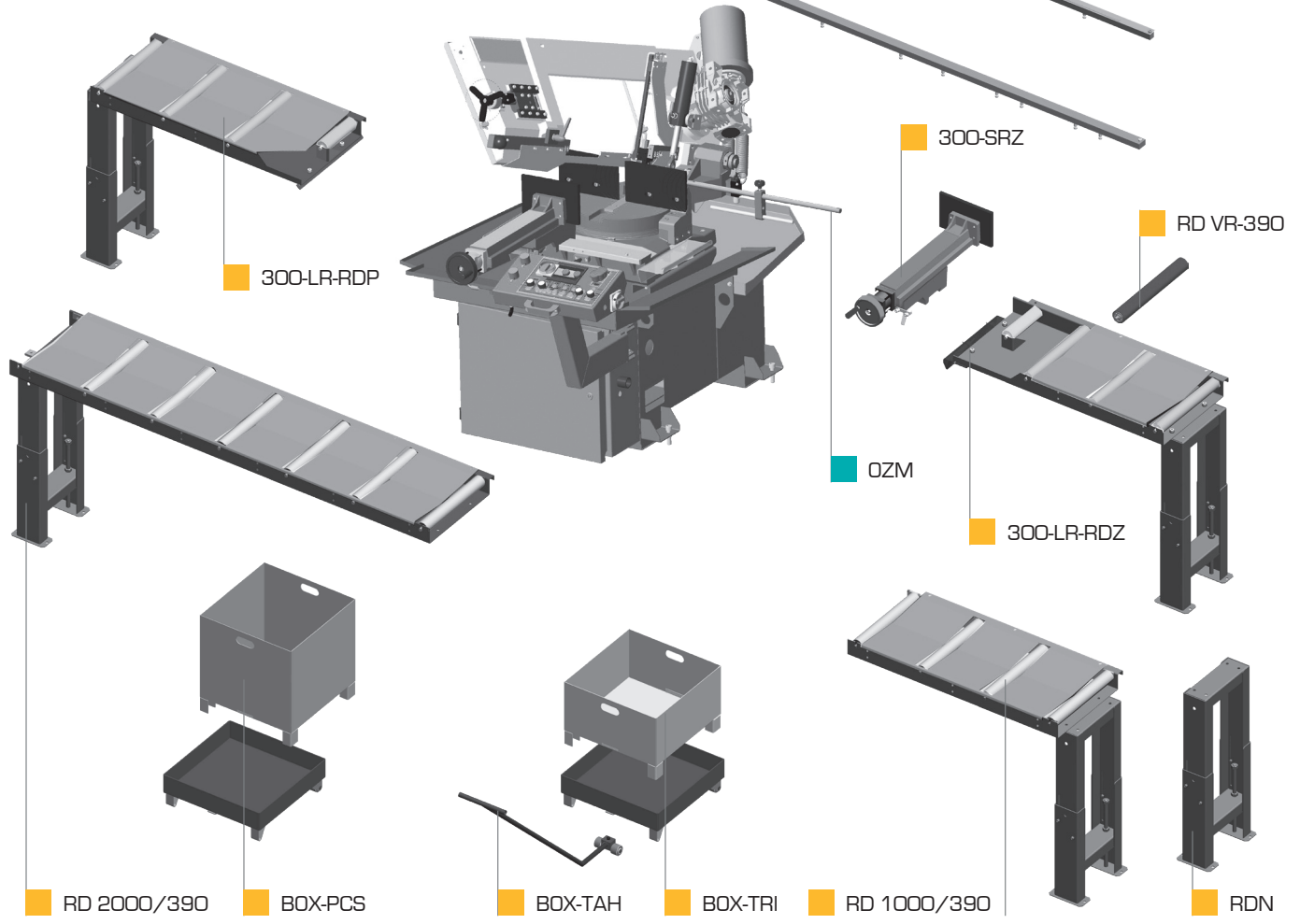
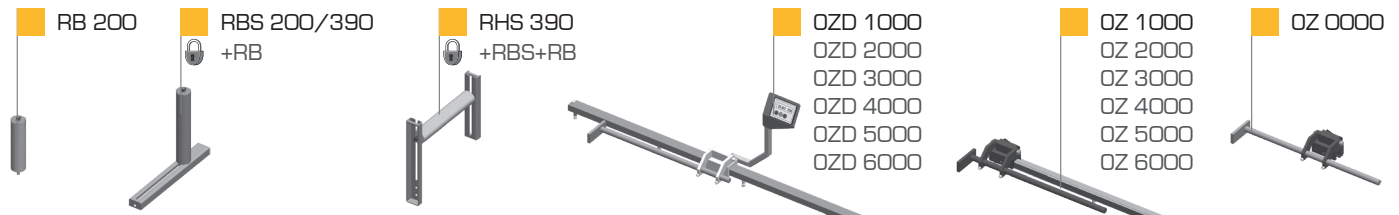

# 300x320 SH-LR (II. generace/generation)

■ STANDARD ■ OPTION



**PEGAS-GONDA s.r.o.**, Čs.armády 322, 684 01 Slavkov u Brna, CZECH REPUBLIC  
 Tel: 00420-544 221 125 (126), Fax: 00420-544 227 389, E-mail: pegas@gonda.cz  
[www.pegas-gonda.cz](http://www.pegas-gonda.cz)

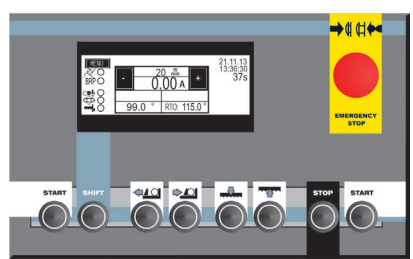

- výrobce si vyhrazuje právo provádět změny technických údajů, technické údaje odpovídají 1.3.2018  
 / producer has the right to make changes of technical data, technical data are valid on 1.3.2018 /  
 - pila na fotografii není vždy v základním provedení, uvedené rozměry odpovídají stroji v základním provedení  
 / the machine in the picture is not always in the basic version, mentioned diameters are for machine in basic version /

CONTROL PANEL: MITSUBISHI