













- součástí pily je přední bezpečnostní kryt: RNT (není na fotografii)
/ front safety fence RNT is standart part of the saw (safety fence RNT its not in the picture)/

360x500 A-CNC-R

| | 0° | 45° | 60° |  a x b |
|---|---------|---------|---------|---|
|  | 360 | 360 | 300 | x |
|  | 250* | 180* | 130* | x |
|  | 500x340 | 440x220 | 310x220 | 500x220 |

|  |  |  | |  | |  |
|---|---|---|------|---|------|---|
| 3x400 V | 3,0 | 20-100 | | 4780x34x1,1 | | 1500 |
| Lmin | Lmax | Bmin | Bmax | Hmin | Hmax | V |
| 2165 | 2940 | 2580 | 2600 | 1455 | 2340 | 800 |

* doporučená hodnota. Při překročení doporučeného maximálního průměru není možné garantovat výkon pilového pásu!
/recommended value. The blade performance cannot be guaranteed when the recommended diameter is exceeded!

 a x b - řezání svazků bez horního přitlaku / cutting of the bundle without top clamping/

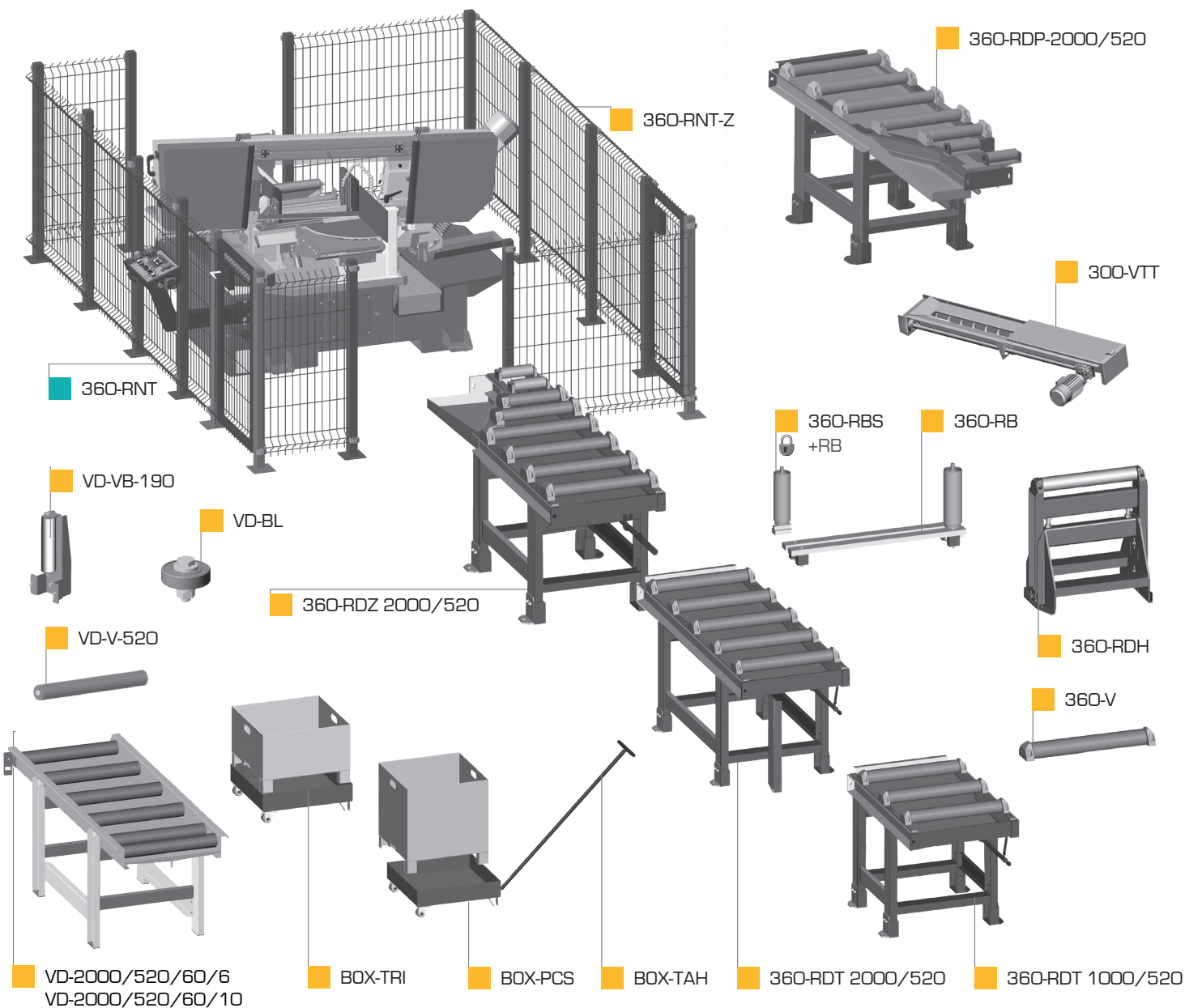
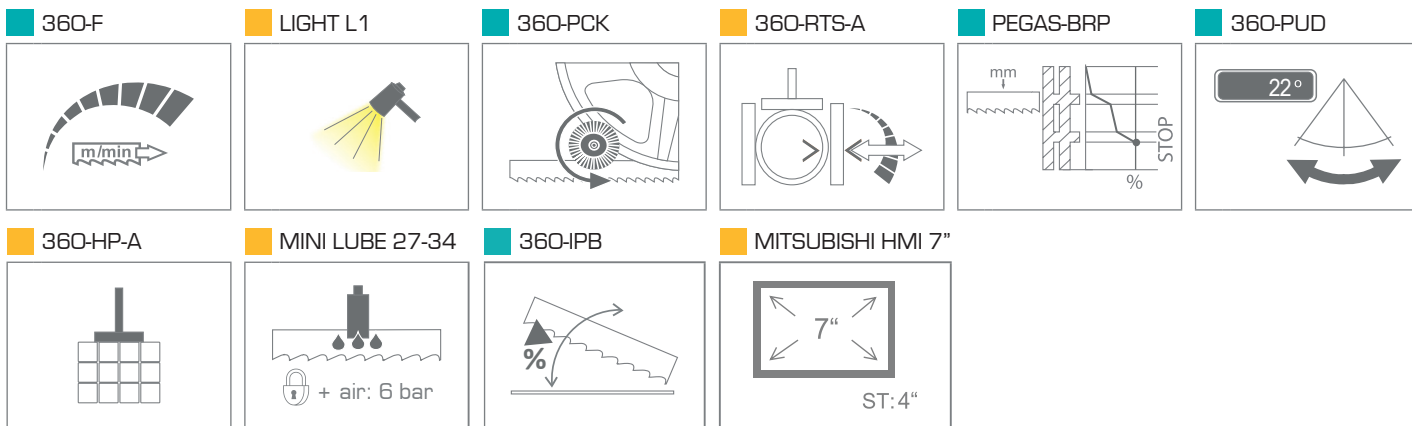

360x500 A-CNC-R

■ STANDARD ■ OPTION



PEGAS-GONDA s.r.o., Čs.armády 322, 684 01 Slavkov u Brna, CZECH REPUBLIC
Tel: 00420-544 221 125 (126), Fax: 00420-544 227 389, E-mail: pegas@gonda.cz
www.pegas-gonda.cz

- výrobce si vyhrazuje právo provádět změny technických údajů, technické údaje odpovídají 1.3.2018
/ producer has the right to make changes of technical data, technical data are valid on 1.3.2018 /
- pila na fotografii není vždy v základním provedení, uvedené rozměry odpovídají stroji v základním provedení
/ the machine in the picture is not always in the basic version, mentioned diameters are for machine in basic version /

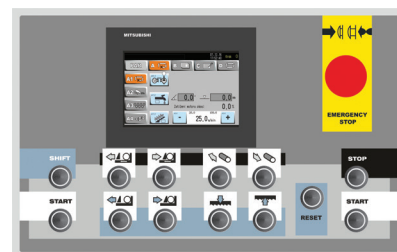

CONTROL PANEL: MITSUBISHI NC