













## 850x1000 HERKULES X-CNC

 mm	 mm	 $\frac{b}{a}$ a x b	 $\frac{b}{a}$ a x b
850	850	1000x850	1000x450
		 m/min	 mm
3x400 V	11,0	15-80	9490x67x1,6 (9490x80x1,6)

	Lmin	Lmax	Bmin	Bmax	Hmin	Hmax	V	 kg
	4800	6320	3140	3830	2820	3260	620	11800
PILA / BAND SAW	4830	6280	1680	x	2820	x		7300
PODAVAČ / FEEDER	3600	x	1910	x	2090	x		4250

\* doporučená hodnota. Při překročení doporučeného maximálního průměru není možné garantovat výkon pilového pásu!  
/recommended value. The blade performance cannot be guaranteed when the recommended diameter is exceeded!

  $\frac{b}{a}$  - řezání svazků bez horního přitlaku / cutting of the bundle without top clamping/

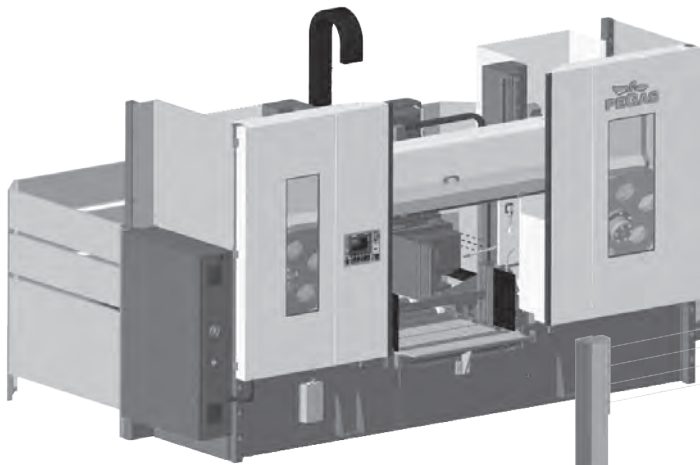
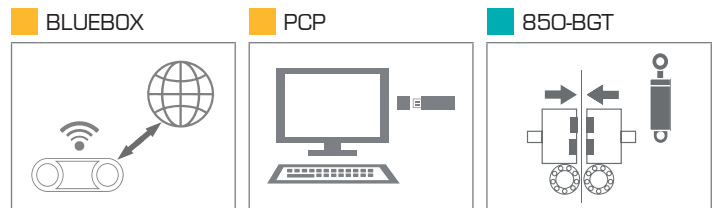
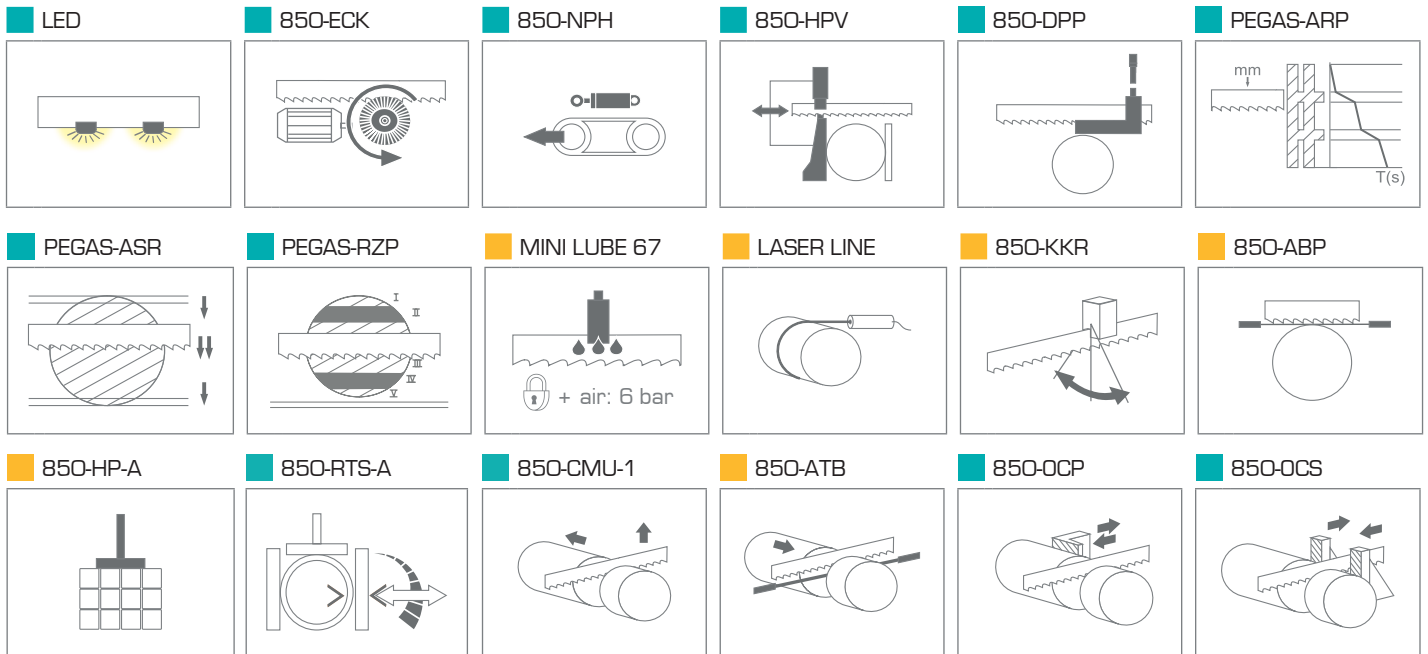

**850-LSG**



**850-RBRS +RBR**



**850-RBR**



**850 DMV 2000**



**850-RBR**

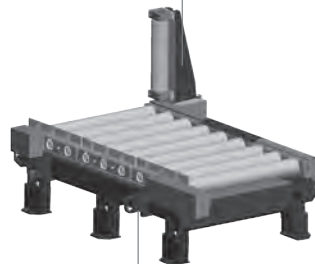

**BOX-TRI-BIG**

**850 RDT 2000/1000**



**850-V +RDT**



**850 TDT 2000/1000**

# 850x1000 HERKULES X-CNC

■ STANDARD    ■ OPTION



**PEGAS-GONDA s.r.o.**, Čs.armády 322, 684 01 Slavkov u Brna, CZECH REPUBLIC  
Tel: 00420-544 221 125 (126), Fax: 00420-544 227 389, E-mail: pegas@gonda.cz  
[www.pegas-gonda.cz](http://www.pegas-gonda.cz)

- výrobce si vyhrazuje právo provádět změny technických údajů, technické údaje odpovídají 1.3.2018  
/ producer has the right to make changes of technical data, technical data are valid on 1.3.2018 /  
- pila na fotografii není vždy v základním provedení, uvedené rozměry odpovídají stroji v základním provedení  
/ the machine in the picture is not always in the basic version, mentioned diameters are for machine in basic version /



CONTROL PANEL:SIEMENS (X-CNC)